



LE Electric Inc.

Employment Application

Applicant Information

Full Name: Last First M.I. Date:

Address: Street Address Apartment/Unit # City State ZIP Code

Phone: Email

Date Available: Social Security No.: Desired Salary:\$

Position Applied for:

Are you authorized to work in the U.S.? YES NO
Have you ever worked for this company? YES NO If yes, when?
How did you hear about us?
Were you referred by a current LE Electric employee? YES NO If so, what's the employee's name?

Education

High School: State: Did you graduate? YES NO
From: To: Diploma:

College: State: Did you graduate? YES NO
From: To: Degree:

Other: State: Did you graduate? YES NO
From: To: Degree:

References

Please list three professional references.

Full Name: Relationship:
Company: Phone:

Full Name: Relationship:
Company: Phone:

Full Name: Relationship:
Company: Phone:

**Previous Employment**

Company: \_\_\_\_\_ Phone: \_\_\_\_\_  
Job Title: \_\_\_\_\_ Supervisor: \_\_\_\_\_  
Responsibilities: \_\_\_\_\_ Starting Salary:\$ \_\_\_\_\_ Ending Salary:\$ \_\_\_\_\_  
From: \_\_\_\_\_ To: \_\_\_\_\_ Reason for Leaving: \_\_\_\_\_  
May we contact your previous supervisor for a reference? YES NO

Company: \_\_\_\_\_ Phone: \_\_\_\_\_  
Job Title: \_\_\_\_\_ Supervisor: \_\_\_\_\_  
Responsibilities: \_\_\_\_\_ Starting Salary:\$ \_\_\_\_\_ Ending Salary:\$ \_\_\_\_\_  
From: \_\_\_\_\_ To: \_\_\_\_\_ Reason for Leaving: \_\_\_\_\_  
May we contact your previous supervisor for a reference? YES NO

Company: \_\_\_\_\_ Phone: \_\_\_\_\_  
Job Title: \_\_\_\_\_ Supervisor: \_\_\_\_\_  
Responsibilities: \_\_\_\_\_ Starting Salary:\$ \_\_\_\_\_ Ending Salary:\$ \_\_\_\_\_  
From: \_\_\_\_\_ To: \_\_\_\_\_ Reason for Leaving: \_\_\_\_\_  
May we contact your previous supervisor for a reference? YES NO

**Disclaimer and Signature**

*I certify that my answers are true and complete to the best of my knowledge.*

*If this application leads to employment, I understand that false or misleading information in my application or interview may result in my release.*

Signature: \_\_\_\_\_ Date: \_\_\_\_\_



***“Connecting Power With Quality” Since 1977***

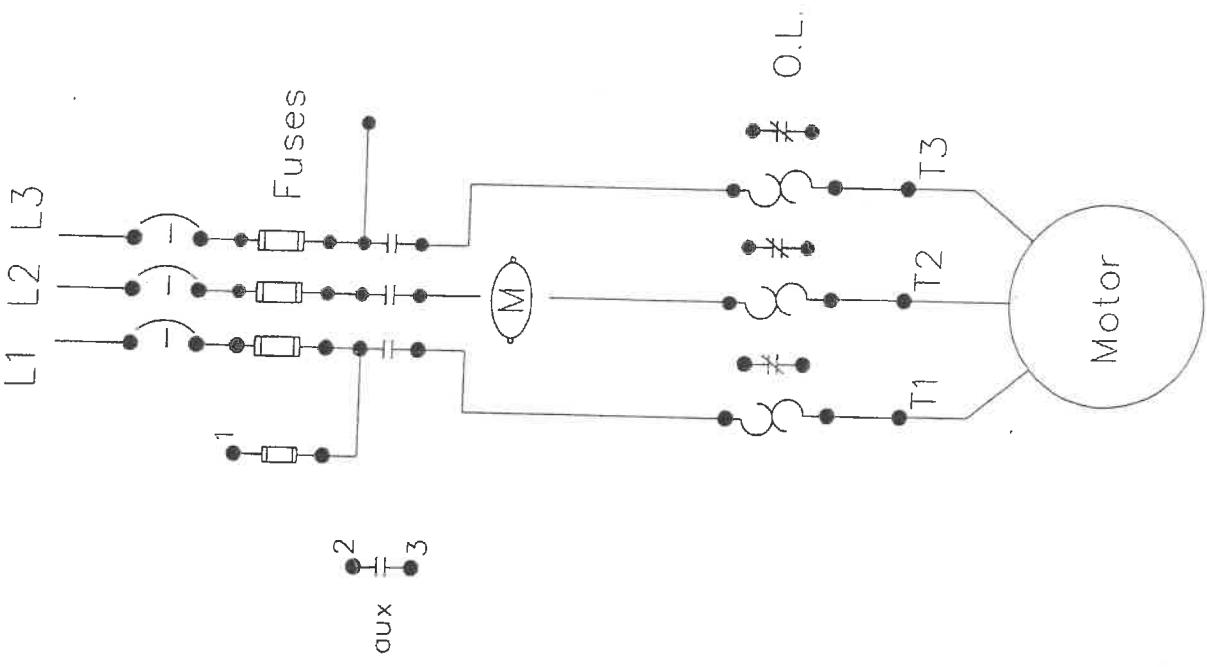

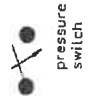
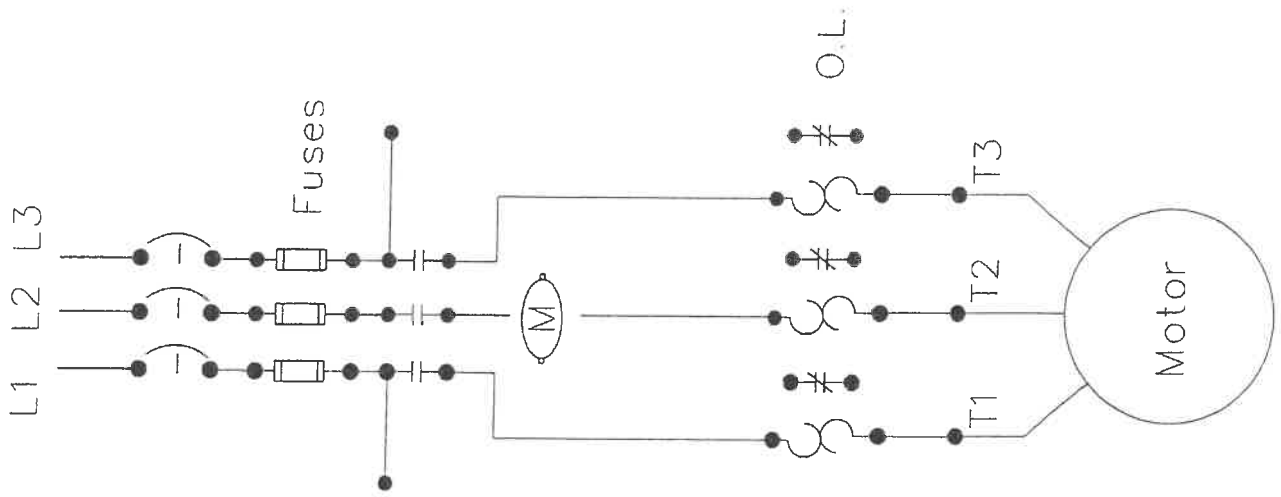

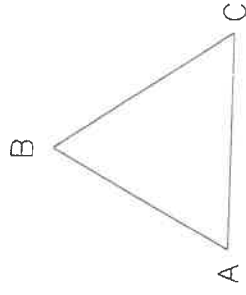
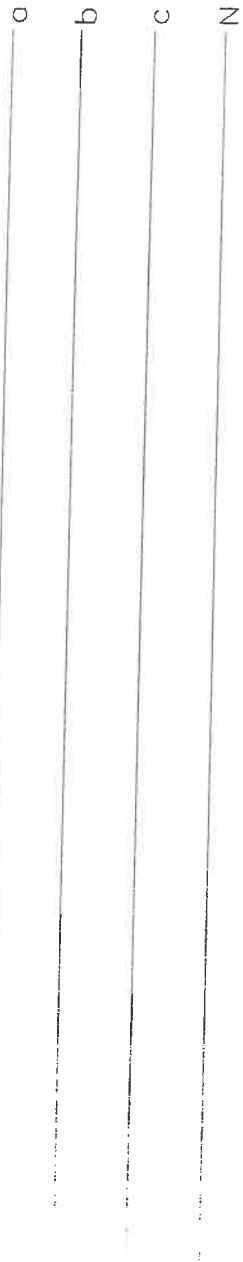
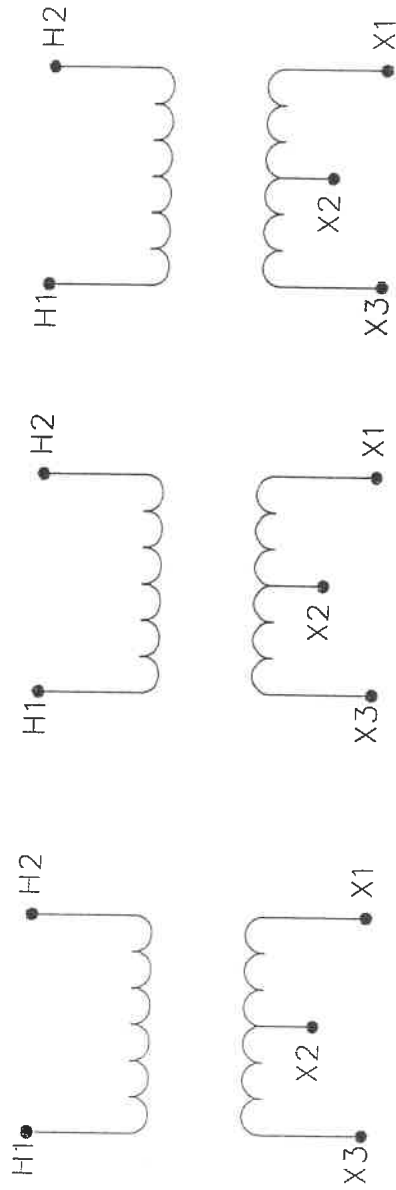
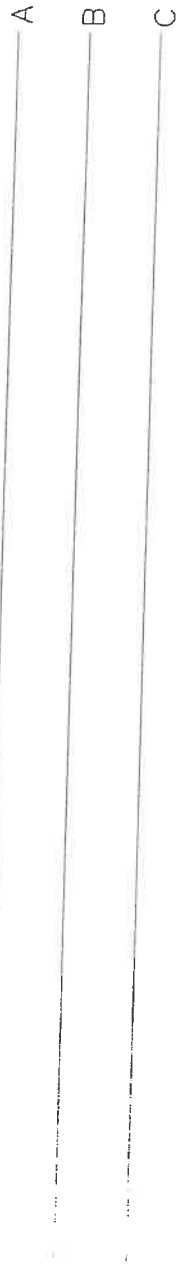

DELTA-DELTA

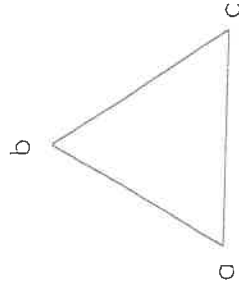

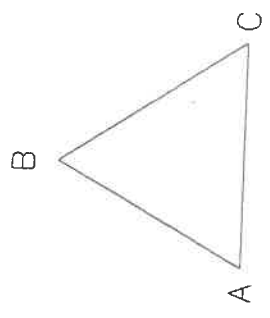
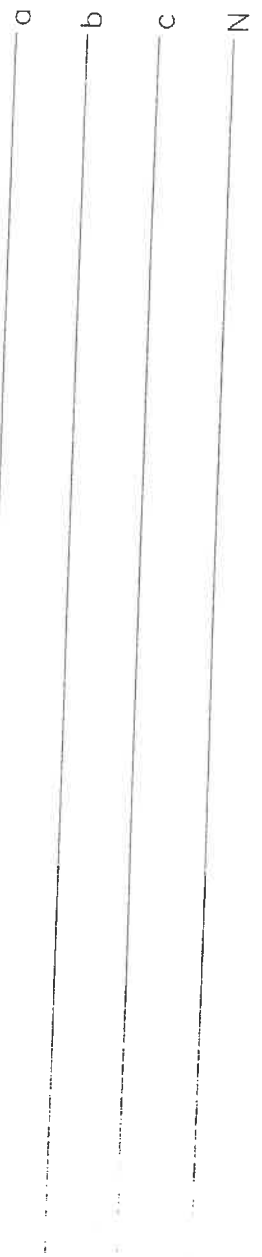
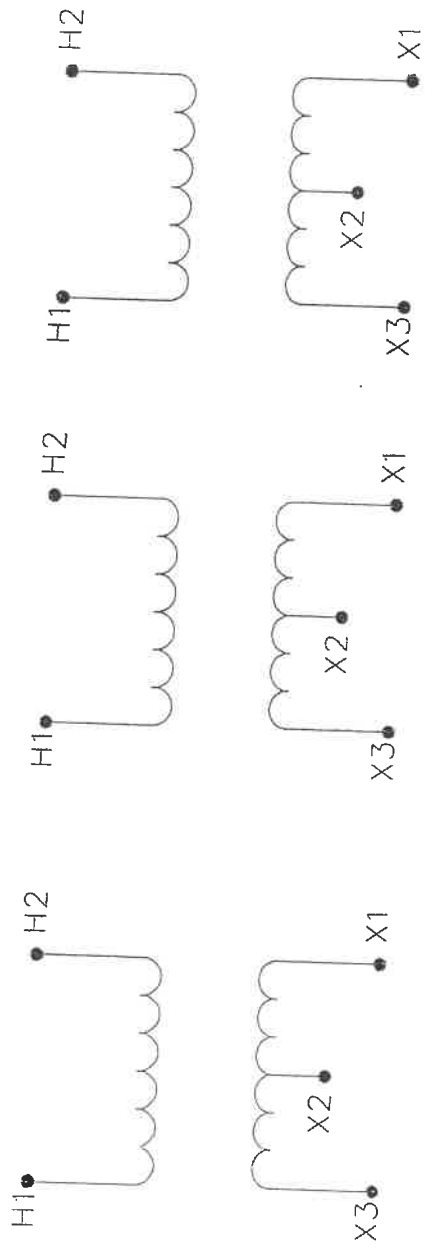
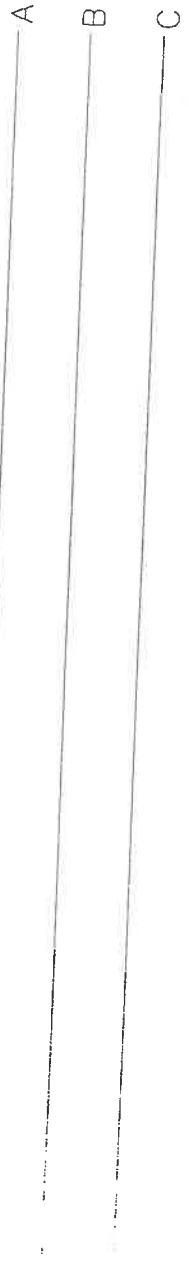

DELTA-WYE

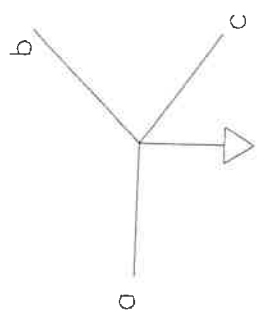

3-way

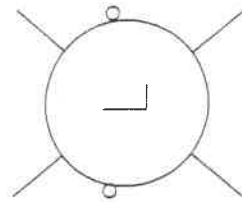

3-way

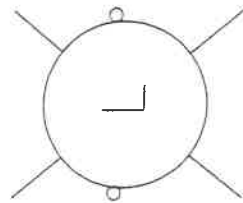
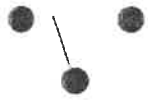



3-way



4-way

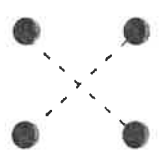

3-way

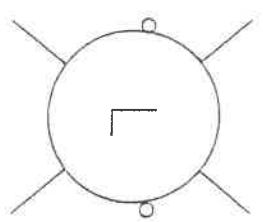
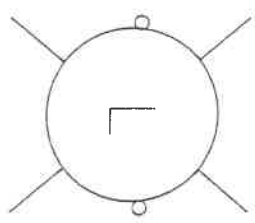



L1



N

